









## Bow Front Desk Shell

LO2/08-22

CONC10	CONC11	DOWEL	GLIDE	TUN013LB	TUN018SC	TUN015BG	PLASTIC CAP	PLASTIC CAP
A  Cam Lock Pin 14Pcs+2Pcs	B  Cam Lock 14Pcs+2Pcs	C  Dowel 9Pcs+2Pcs	D  Glide 4Pcs	E  L-Bracket 5Pcs	F  Screw #4*3/8" 30Pcs+5Pcs	G  Grommet 2Pcs	H  DEEP CAMLOCK CAP 6Pcs+1Pcs	I  CAMLOCK CAP 8Pcs+1Pcs

### STEP1

### STEP2

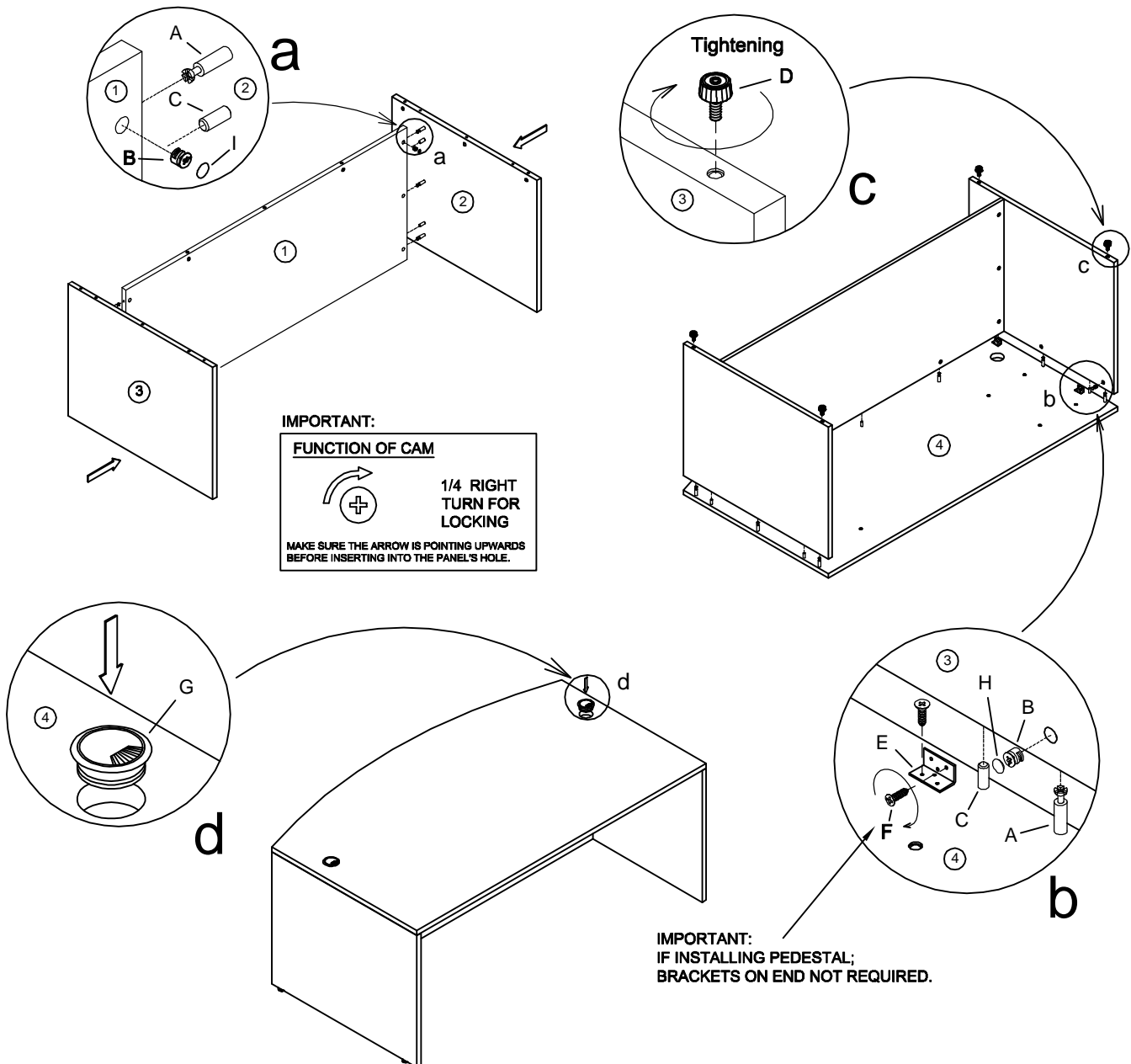

### IMPORTANT NOTE:

- It is advisable to assemble unit on a carpet to avoid scratch.
- Check to be sure that you have all parts and hardware.
- Don't tighten all screws/bolts until all completely assembled.
- It is recommended to require 2 persons to complete the assembling.