

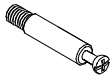







## Reception Desk Shell - No Transaction Top

LO2/08-22

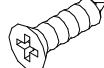
<b>A</b>  Cam Lock Pin 16+2Pcs	<b>B</b>  Cam Lock 16+2Pcs	<b>C</b>  Dowel 4+2Pcs	<b>D</b>  Glide 4Pcs	<b>E</b>  L-Bracket 6Pcs	<b>F</b>  Screw #4*16 36+5Pcs	<b>G</b>  60mm black Grommet 2Pcs	<b>H</b>  Deep Camlock cap 12+4Pcs	<b>I</b>  Camlock cap 10+4Pcs
---	--	--	--	--	--	--	--	---

### STEP1

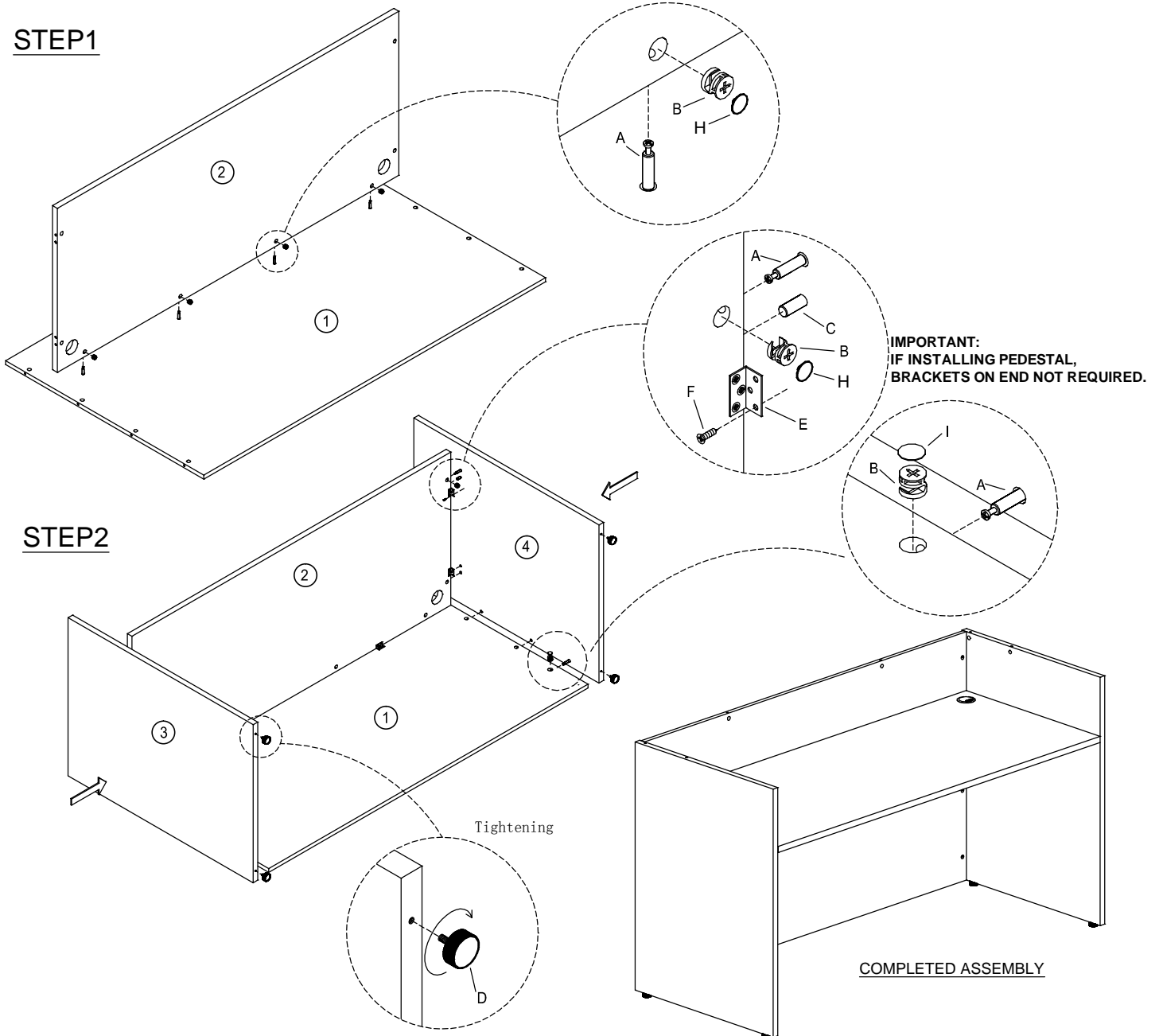

### STEP2

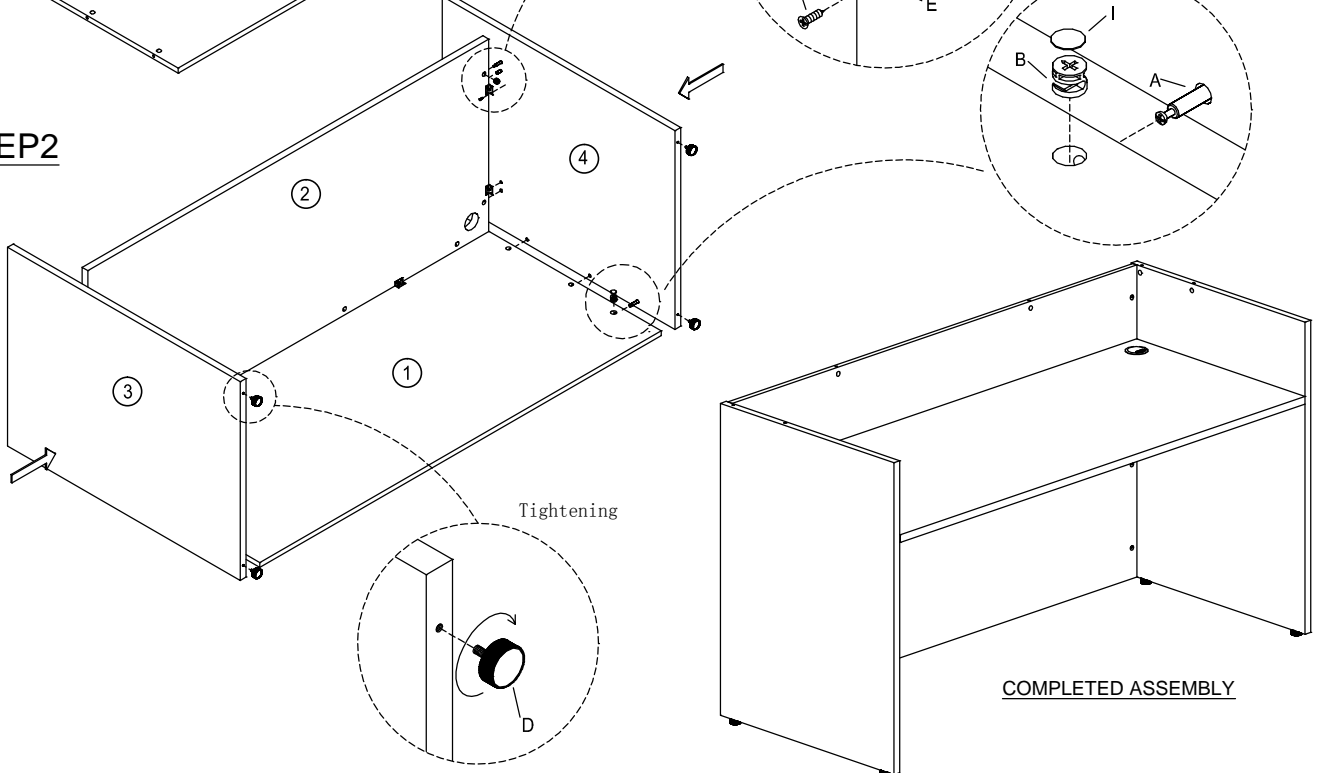

#### IMPORTANT NOTE:

- It is advisable to assemble unit on a carpet to avoid scratch.
- Check to be sure that you have all parts and hardware.
- Don't tighten all screws/bolts until all completely assembled.
- It is recommended to require 2 persons to complete the assembling.
- If installing pedestal, brackets on end not required.

#### IMPORTANT:

##### FUNCTION OF CAM



1/4 RIGHT  
TURN FOR  
LOCKING

MAKE SURE THE ARROW IS POINTING UPWARDS BEFORE INSERTING INTO THE PANEL'S HOLE.